

COLLEZIONE

Kajal

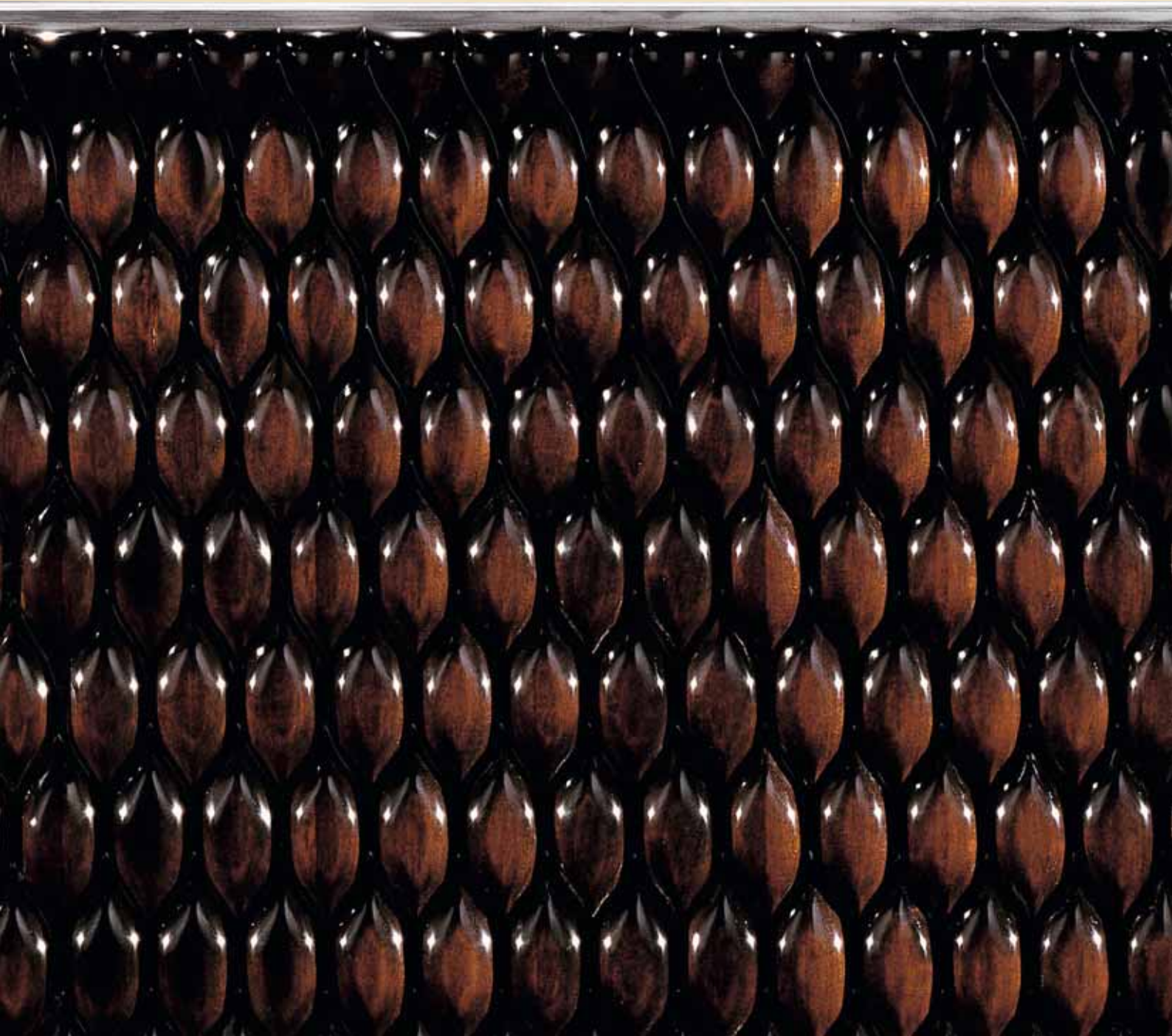

La collezione *Kajal* nasce dalla sensualità di uno sguardo,
dal sottile contorno che delinea il fascino del volto di una donna,
esaltandone l'esotica bellezza.

Fascino e sensualità che si esprimono nell'abbinamento tra
l'essenzialità delle linee e la preziosità dei materiali.

La collezione *Kajal* è dedicata a chi ama trovare la ricercatezza nella semplicità.
Kajal crea giochi e contrasti attraverso l'elegante accostamento della pergamena naturale
al legno scolpito incorniciati da raffinati particolari di ottone nickelato.

Kajal Collection comes from the sensuality of a look,
from the narrow contour that shapes the glamour of a woman's face,
exalting her exotic beauty.

Glamour and sensuality expressing through the combination
of essential lines with precious materials.

Kajal is dedicated to those who love to find elegance in simplicity.
Kajal plays with contrasts through the elegant combination of natural parchment
with sculpted wood enframed in exquisite nickel plated brass frames.

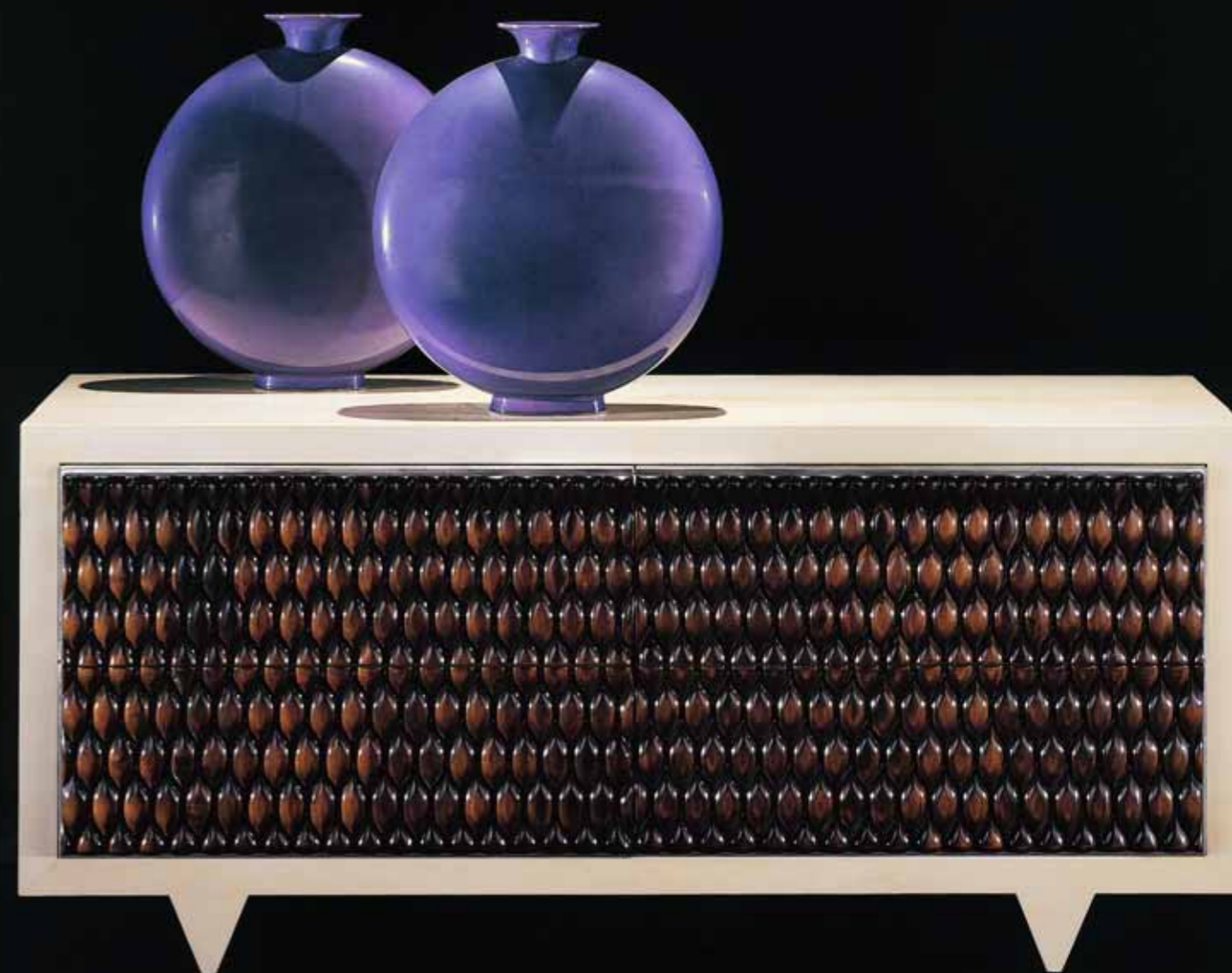

Dining Table 3100

Chair 3101



Armchair 3112

Side Table 3110

Lamp 3153



Show Case 3106



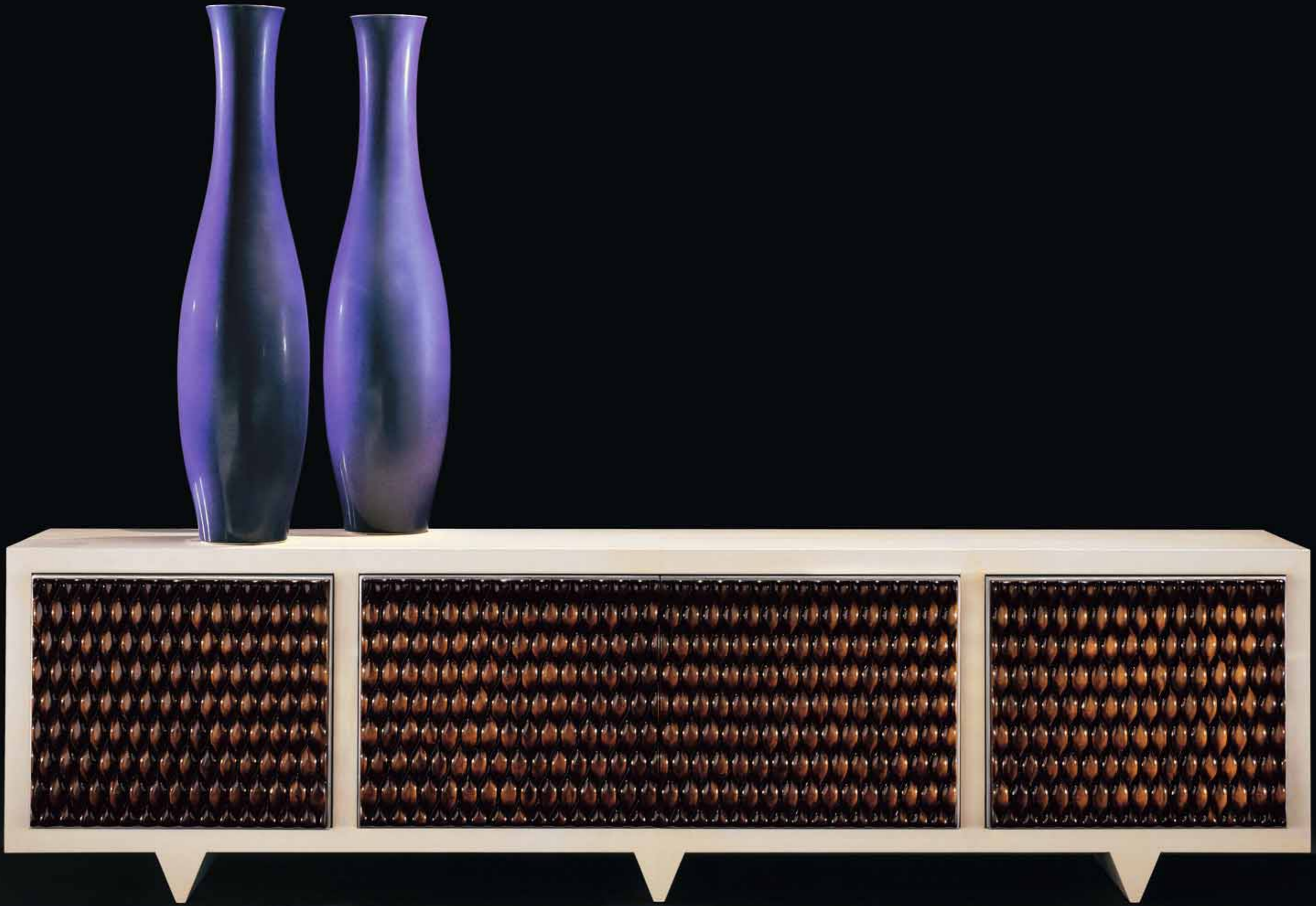

Desk 3113

Armchair 3114



Linee essenziali e forme sinuose, abbinata a materiali naturalmente ricercati, creano il fascino e la forza di questa nuova collezione.

Essential lines and sinuous shapes, combined with naturally refined materials, create the glamour and the strength of this new collection .

Per creare uno spazio elegante, dove ritrovare il piacere dell'essenzialità senza rinunciare all'eleganza e alla ricercatezza.

Kajal creates an elegant atmosphere, where the pleasure of essentiality does not renounce elegance and refinement.



Sideboard 3105

Coffee Table 3111

Armchair 3112

Lamp 3154



Kajal è uno sguardo che ci invita a viaggiare verso mete lontane.

Kajal is a glance that invites us to travel toward far destinations.

L'essenzialità della pergamena esalta l'effetto visivo del legno scolpito,
le cui forme sinuose e arrotondate esprimono immediata sensualità.

The essentiality of parchment exalts the visual effect of the sculpted wood,
whose sinuous shapes immediately express sensuality.



Consolle 3104

Pouff 3107

Lamp 3152

Lamp "Nirvana" 3151



Pouff 3108



Lamp 3150

Lamp 3153

Lamp 3154

Lamp 3152



Sideboard 3103

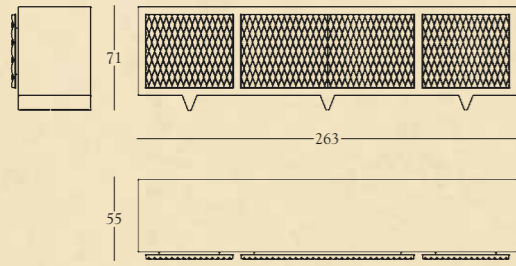

Sideboard 3105

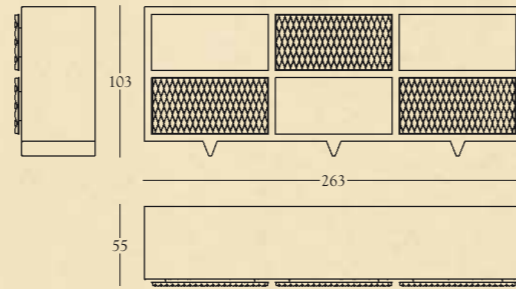

Console 3104

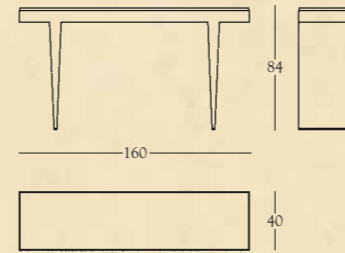

Side Table 3110

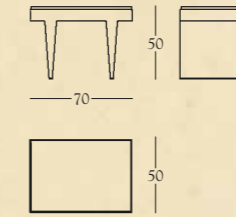

Coffe Table 3111

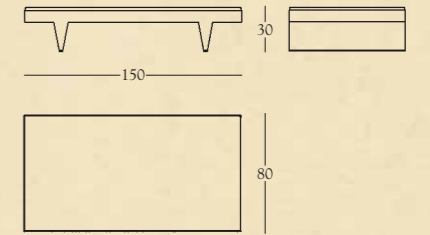

Show Case 3106

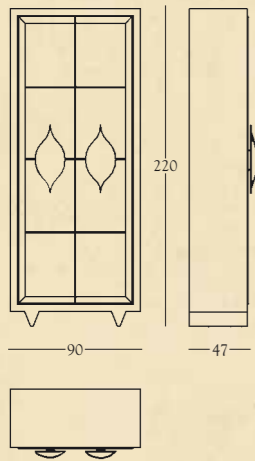

Chest of Drawers 3109

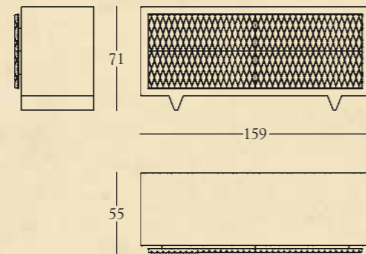

Armchair 3112

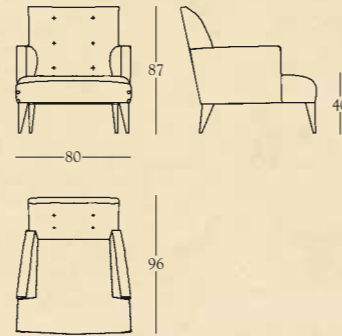

Desk 3113

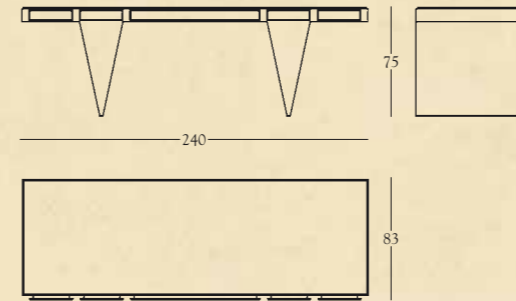

Dining Table 3100

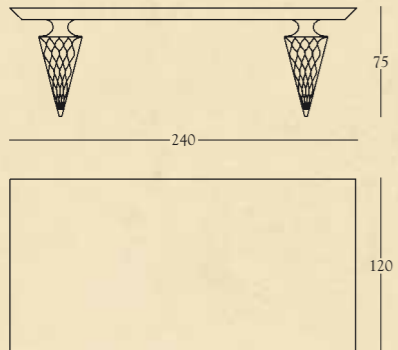

Chair 3101

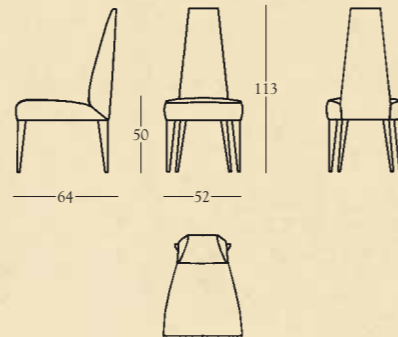

Armchair 3114

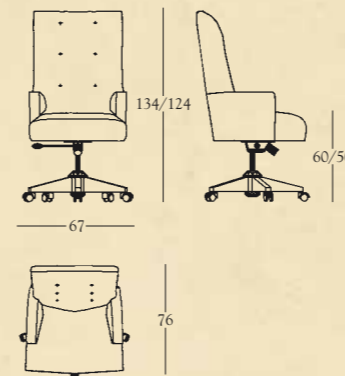

Armchair 3115

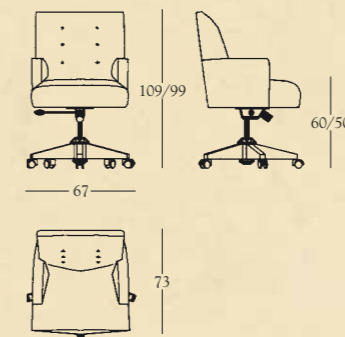

Lamp 3150

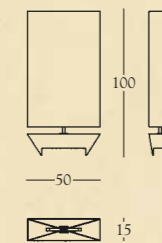

Lamp 3151

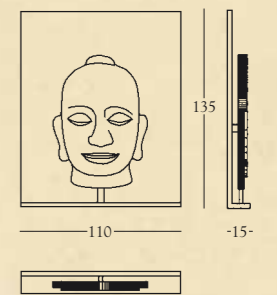

Pouff 3107

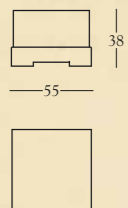

Pouff 3108

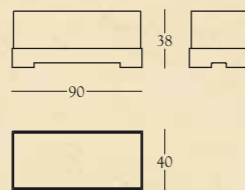

Lamp 3152



Lamp 3153

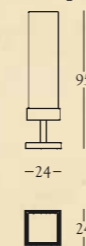

Lamp 3154

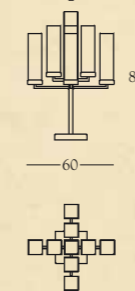

 tura®
design italiano interni esclusivi

Tura Iniziative di Arredamento srl _ 20824 Lazzate / MI / Italy Via Libertà, 121 tel +39 02 963 200 37 r.a. fax +39 02 963 280 25 info@tura.it www.tura.it

